

In General

The suction lances type series SL-02 are used for the withdrawal of chemicals from tanks.

The suction lances can be mounted height adjustable through a barrel connection adapter into a tank cover (accessories, not within scope of delivery) or put directly into the tank.

Integrated connection for feedback pipe from relief valve.

Before commissioning and while operating the sera - suction lance the regulations valid at the place of installation must be strictly observed.

CAUTION !



Pay attention to the safety data sheet of the medium conveyed!
Take appropriate accident prevention measures to avoid that operators are endangered by the used conveying media!

A sufficient tank aeration and deaeration must be ensured!

The suction lances are only suitable for gas-tight operation in connection with the barrel connection adapter ! (see accessories page 4).

Note the chemical resistance of the used medium contacted materials!

Range of use

For dosing pumps with a capacity of max. 200 litre/hour and resembling water media (up to max. 100 mPas, with a density of up to > 1kg/dm³).

Type code

SL	-	02		(1)	Designation	SuctionLance
(1)		(2)		(2)	Qty. of switching points	

Materials

(medium contacted)	
Suction lance	PVC-U
Connection seals	FPM, EPDM or FEP-covered
Suction basket and level switch	PP
Foot valve	PVDF-FRP
Valve seal and ball	PTFE

Dimensions

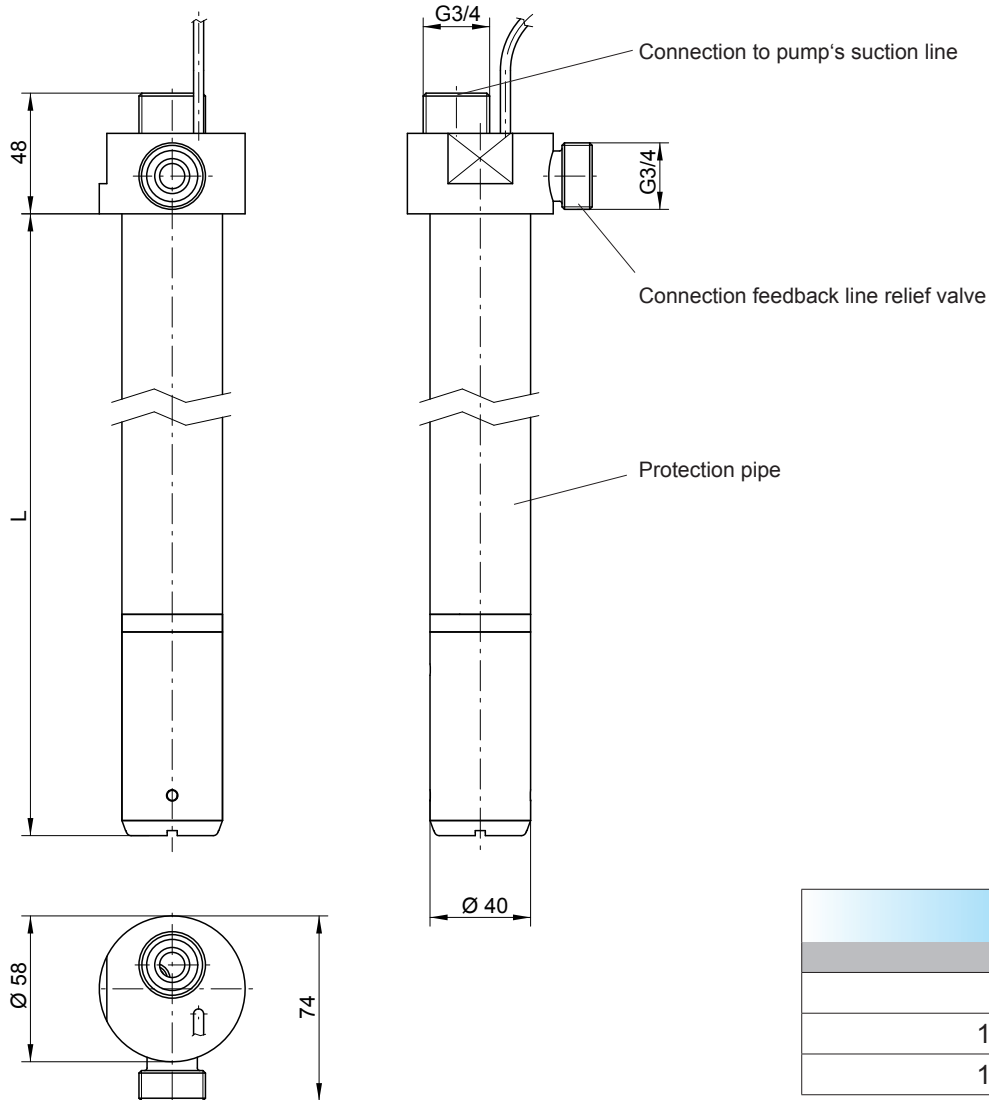

Technical data

Mounting hole	min. 42 mm
Temperature range	>0°C ... 40°C (water)

Electrical data of switch(es)	
Rupturing capacity	10 W / 12 VA
Switching current	0,5 A
Turn-on voltage	Protection low voltage (≤ 48V AC/DC)
Enclosure	IP65 (ICE529)
Contact function	Level switch 1-stage: closing or opening when floating down * Level switch 2-stage: closing when floating down

* Reverse operating when turning the float axially for 180°. Pump parameters have to be adjusted! (C-series).

Filling levels with level messages (switching points)

The level indicated for switching points are referring to density 1 kg/dm³. Values S1 und S2 are changing for media with a higher density.

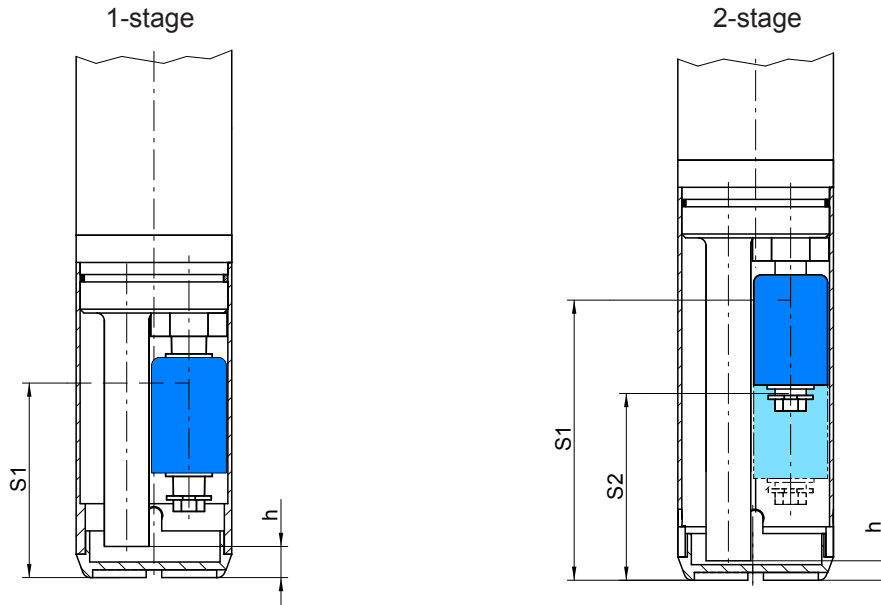



Switching points

	1-stage	2-stage
Switching point S1	50 mm	72 mm
Switching point S2	---	48 mm
Remaining quantity h	approx. 8 mm (in case of suction lance with contact to bottom)	approx. 5 mm (in case of suction lance with contact to bottom)

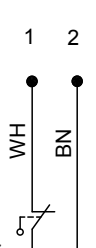

Electrical connections

for connection to controllable dosing pumps of sera - C-series

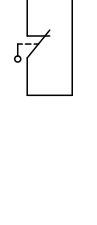
Wiring diagram

	1-stage	2-stage
S1 Opener		
S1 Closing contact		

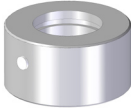
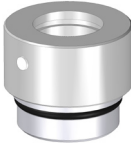
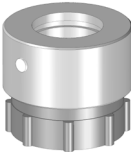

Accessories				
Image	Designation	Description	Material	Article-No.
	Barrel connection adapter	for external thread G=S56x5 DIN2781	PP/FPM	90011762
			PP/EPDM	90011763
	Barrel connection adapter	for internal thread G=2 fine thread steel cask DIN-ISO 228-1	PP/FPM	90011770
			PP/EPDM	90011771
	Barrel connection adapter	for internal thread G=v. empty/tri-sure BCS 56x4 EN12708	PP/FPM	90011768
			PP/EPDM	90011769
	Barrel connection adapter	for external thread G=DIN51	PP/FPM	90011766
			PP/EPDM	90011767
	Barrel connection adapter	for wall bushing G=2 wall thickness S=max. 6 mm	PP/PVC/FPM	90011772
			PP/PVC/EPDM	90011773
	Connection cable	approx. 3 m with connection plug M12		