

PROFIBUS INTERFACE MODULE



NOTE

Keep the operating manual for future use!

ATTENTION

Subject to technical modifications!

About this instructions

Special notes in these instructions are marked with text and danger symbols.

NOTE

Notes or instructions that facilitate work and ensure a safe operation.

ATTENTION

The non-observance of these safety instructions can result in malfunctions or material damages.

WARNING

The non-observance of these safety instructions can lead to material damages and personal injuries.

Quality notes

The **sera** quality management and quality assurance system is certified in accordance with DIN EN ISO 9001:2015. The **sera** product complies with the applicable safety requirements and accident prevention regulations.

SAFETY INSTRUCTIONS	4
Personnel qualification and training.....	4
Dangers in the case of non-observance of the safety instructions	4
Safety-conscious working	4
Safety instructions for owner / operator	4
Improper operations	4
Intended use.....	4
TRANSPORT / STORAGE	5
Transport	5
Storage.....	5
PRODUCT DESCRIPTION	6
Type plate	6
Accessoires	6
TECHNICAL DATA.....	7
Electrical data.....	7
Ambient conditions.....	7
Dimensions.....	7
ELECTRICAL CONNECTIONS	8
Installation example / bus diagram	10
Stub cables	11
Bus cable.....	11
COMMISSIONING	12
OPERATION	13
LED operation indicators	13
Operation window.....	13
Operating Modes	14
Modules	14
Explanation of the modules	14
PROFIBUS acyclic data exchange	14
Modules / Input.....	15
Modules / Output	16
Settings (parameters)	16
Data from module to the master	23
MESSAGE.....	29
Diagnostics signals.....	29
Error message.....	29
MAINTENANCE / DECOMMISSIONING / DISPOSAL.....	30
Maintenance and cleaning.....	30
Decommissioning	30
Disposal.....	30



WARNING

Before commissioning, installing and during operation of the **sera** dosing pump the respective regulations valid at the place of installation are to be observed!

Compliance with these operating instructions and, in particular, the safety instructions, helps to:

- Prevent danger to people, machines and the environment.
- Increase reliability and service life of the product and the complete system.
- Reduce repair costs and downtimes.

Personnel qualification and training

The personnel for operation, maintenance, inspection and installation must be suitably qualified for their tasks. The owner must clearly define responsibility and supervision of the personnel.

If the personnel do not have the knowledge required, then personnel is to be trained and instructed correspondingly. Such training can be provided by the manufacturer / supplier upon order of the owner. In addition, the owner has to ensure that personnel have understood the operating instructions completely.

Dangers in the case of non-observance of the safety instructions

Non-observance of the safety instructions can result in hazards both for persons as well as for the environment and the product, and can, for example, cause the following hazards:

- Failure of important functions of the product.
- Failure of prescribed methods for maintenance and repair.
- Danger to people from electrical, mechanical and chemical influences.

Safety-conscious working

The safety instructions shown in this operating manual, the existing national accident prevention regulations and any internal working, operating and safety regulations of the owner must be observed.

Safety instructions for owner / operator

Danger caused by electrical energy is to be avoided.

Improper operations

Operating safety of the supplied product is only guaranteed if the product is used as intended, according to the descriptions in Chapter „Intended use“ of these operating instructions.

Intended use

The **sera** product is only to be deployed according to the intended purpose stated in the product description and the acceptance test certificate.

If the product is to be used for other applications, then the suitability of the product for the new operating conditions must be discussed with **sera** beforehand!

Criteria for operation in accordance with the intended use:

- Operating conditions at the place of installation.
- Voltage supply.

General

sera products are checked for perfect condition and function previous to shipment.

Check for transport damage immediately after arrival of goods. If damage is found, this is to be reported immediately to the responsible carrier and the manufacturer.

Storage

An undamaged packaging protects the unit during storage and should only be opened when the product is installed.

Proper storage increases the service life of the product and includes prevention of negative influences such as heat, moisture, dust, chemicals etc.

The following storage specifications are to be observed:

- Storage place: cool, dry, dustfree and slightly ventilated
- Storage temperature and relative air humidity see Chapter „TECHNICAL DATA“.
- The maximum storage time for the standard packaging is 12 months.

If these values are exceeded, metal products should be sealed in foil and protected from condensation water with a suitable desiccant.

Do not store solvents, fuels, lubricants, chemicals, acids, disinfectants and similar in the storage room.

PRODUCT DESCRIPTION

The INTERFACE MODULE must only be used as communication interface between a controllable sera dosing pump and a PROFIBUS network.

A proprietary **sera** protocol is used for the internal communication between INTERFACE MODULE and dosing pump.

i NOTE

The sera dosing pump PROFIBUS option is integrated in the network via the device master data (DMD) file which must be integrated in the development environment. This file contains the characteristics of the pump and information for the communication capability.

The DMD file can be downloaded by scanning the QR code (see type plate) or directly from the sera website www.sera-web.com.

Type plate

The INTERFACE MODULE is provided with a type plate at the factory. The information on the type plate is explained below.

No.	Designation
1	Type
2	Max. power consumption
3	Supply voltage
4	Protection rating
5	QR code (for the DMD file)



Accessoires

The supply includes the following accessories:

- Wall mount (1)
- Sensor cable (2)

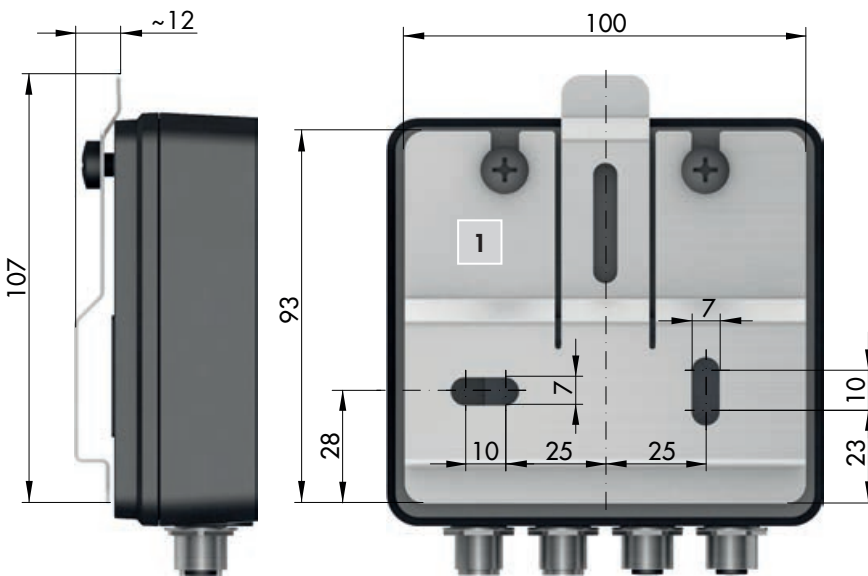

Electrical data

PROFIBUS interface	PROFIBUS DP-V1 (slave)
	GSD File sera seraOFA2.gsd
Transmission rate	9.6/19.2/45.45/93.75/187.5/500 kbit/s 1.5/3/6/12 Mbit/s Automatic baud rate detection
Supply voltage	24 V DC
Max. power consumption	1 W

Ambient conditions

Max. height above sea level	1000 m
Max. relative humidity	90%
Protection rating	IP65
Electrical protection class	III
Ambient temperature	0 °C to 40 °C

Dimensions

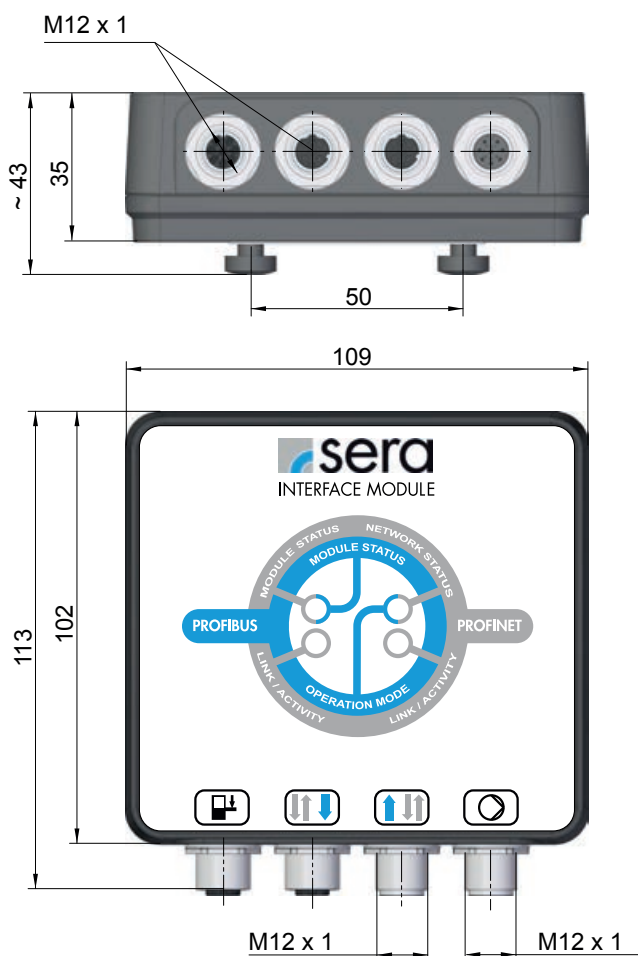

ELECTRICAL CONNECTIONS

⚠ ATTENTION

The electrical connection must be made by qualified personnel in compliance with the local regulations.

⚠ WARNING

Ensure absence of voltage of all cables and devices for the installation of electrical components!





Contact with stripped wires or live components can result in serious injuries or even death.
Any short-circuit can cause severe and expensive damage to the assemblies.

⚠ WARNING

Damaged cables should always be replaced!

⚠ WARNING

In order to guarantee the IP65 protection rating, all unused connections should be provided with a blanking plug.

	Interface	Assignment	Function
1	 Level connection	8-pole	Pre-alarm and dry running protection
2	 PROFIBUS Output *	5-pole	Connection to the PROFIBUS network or terminating resistor (5)
3	 PROFIBUS Input *	5-pole	Connection to the PROFIBUS network
4	 Pump connection	8-pole	Data transfer between pump and INTERFACE MODULE

* no Y-connector necessary



The field bus box modules are connected via the supplied connection cable.
The INTERFACE MODULE has a socket and a plug, whereby no Y-connector is necessary.
The supply voltage (+5 V DC) for the terminating resistor is only applied on the socket.
The terminating resistor is only available as plug connector.

Level connection (1)

Pin	Wire colour	Function (factory setting)
Pin 1	WH (white)	not assigned
Pin 2	BN (brown)	not assigned
Pin 3	GN (green)	not assigned
Pin 4	YE (yellow)	not assigned
Pin 5	GY (grey)	not assigned
Pin 6	PK (pink)	Pre-alarm level
Pin 7	BU (blue)	Dry run
Pin 8	RD (red)	GND

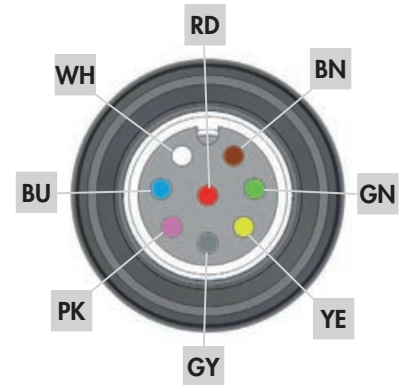

The inputs can be switched using a floating contact signal.
Pre-alarm and dry running are set to normally open floating contacts at the factory.
The sockets of the connections are A-coded and the assignments of the functions are symbolically labelled.

PROFIBUS output (2)

Pin No.	Signal	Description
Pin 1	VP	+5 V supply for terminating resistor
Pin 2	A-line	Negative RxD/TxD
Pin 3	GND bus	Data ground
Pin 4	B-line	Positive RXD/TxD
Pin 5	Shield	Not connected internally, connected internally with PROFIBUS cable with shield
Thread	Cable shield	Must be connected externally with PE via cable filter according to PROFIBUS standard

PROFIBUS input (3)

Pin No.	Signal	Description
Pin 1	NC	NC
Pin 2	A-line	Negative RxD/TxD
Pin 3	GND bus	Data ground.
Pin 4	B-line	Positive RXD/TxD
Pin 5	Shield	Not connected internally, connected internally with PROFIBUS cable with shield
Thread	Cable shield	Must be connected externally with PE via cable filter according to PROFIBUS standard



ATTENTION

The M12 socket is inversely coded and has 5 pins. Pin 1 is 5 V DC and Pin 3 is GND for the active terminating resistor. These must never be used for any other functions as this can result in destruction of the device.
Pin 2 and Pin 4 carry the data of the PROFIBUS communication. These must never be reversed otherwise the communication is disrupted. Pin 5 is the shield that is not internally connected to the module.

Anschluss Pumpe (4)

Pin No.	Function
Pin 1	+24 V supply voltage
Pin 2	Communication IM1
Pin 3	Communication IM2
Pin 4	not assigned
Pin 5	Communication IM3
Pin 6	Pre-alarm level
Pin 7	Dry run -
Pin 8	GND

Installation example / bus diagram

All devices are connected in a bus structure (line).
 Up to 32 nodes (master or slaves) can be networked within one segment.
 The first and the last device must be provided with a terminating resistor. The bus segments are connected to the overall network with repeaters (amplifiers), but remain electrically isolated. Up to maximum 126 nodes (including repeaters) can be connected within the overall network.
 The bus nodes are identified by the bus address. Each address must be unique and may only be assigned once.

i NOTE

The minimum cable length between the individual nodes must be at least 1 m for transmission rates of more than 1.5 Mbit/s. It must be ensured for the cable installation that the PROFIBUS cable does not run parallel with other live cables.

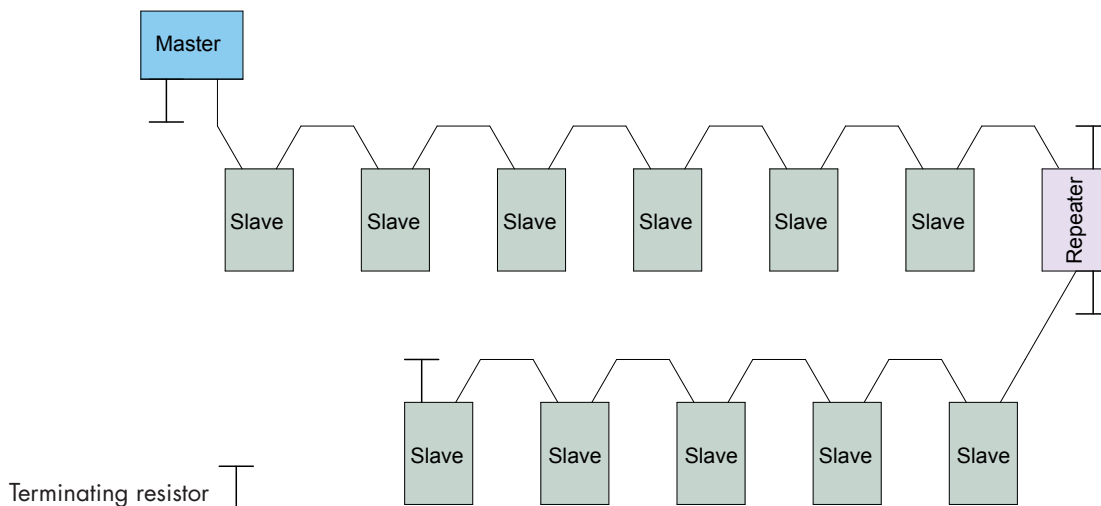

Stub cables

Stub cables (2) (with Y or T distributing piece) are branches from the main bus line (1) to the node.

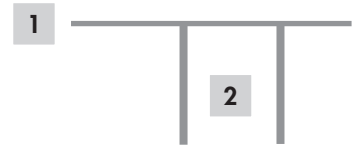

Stub cables are never allowed if the transmission rates exceed 1.5 Mbit/s. Stub cables may be used for transmission rates of less than or equal to 1.5 Mbit/s, if the limit values stated in the table are not exceeded.

Transmission rate	Total of stub cables *
> 1.5 Mbit/s	none
1.5 Mbit/s	6.7 m
500 kbit/s	20 m
187.5 kbit/s	33 m
93.75 kbit/s	100 m
19.2 kbit/s	500 m

* Total of all stub cables within a segment for PROFIBUS cable of 30 pF/m

The maximum cable length depends on the transmission rate. For transmission rates greater than 1.5 Mbit/s, a minimum cable length of 1 m between two nodes is recommended.

Transmission rate	Maximum cable length
> 1.5 Mbit/s	100 m
1.5 Mbit/s	200 m
500 kbit/s	400 m
187.5 kbit/s	1000 m
93.75 kbit/s	1200 m
45.45 kbit/s	1200 m
19.2 kbit/s	1200 m
9.6 kbit/s	1200 m

Bus cable

Cables with the following specifications must exclusively be used for new installations:

- Characteristic impedance 135...165 ohm (resistance for high-frequency signals)
- Capacitance <30 pF/m
- Loop resistance 110 ohm/km
- Wire diameter 0.64 mm
- Wire cross section > 0.34 mm²

COMMISSIONING

- Disconnect voltage.
- Connect INTERFACE MODULE (1) to the **sera** pump (2) (see „Electrical Connections). Observe earthing.



- Apply voltage.
- Pump starts.
- Module status (3) lights green.
- The “INTERFACE” operating mode must be enabled and can be selected for operating modes.
- Set the address for PROFIBUS (see chapter „Settings (parameters”).

	INTERFACE
	Manual
	100.0 % freq.
	Σ 0 N

LED operation indicators

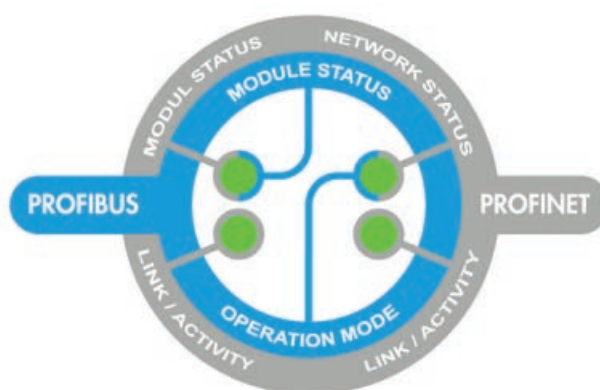

MODULE STATUS	<input type="radio"/> off	<input checked="" type="radio"/> green	<input type="radio"/> red
Operational readiness		x	
Diagnostics notification is pending		flashes	
Module error			x
not initialised	x		

OPERATION MODE	<input type="radio"/> off	<input checked="" type="radio"/> green	<input type="radio"/> red
On-line, data exchange		x	
On-line, ready		flashes	
Parametrisation error			flashes once f or a short time
PROFIBUS configuration error			flashes twice for a short time
not initialised	x		

Operation window

INTERFACE MODULE is initialised.

No BUS/NETWORK connection is established or there is no data exchange.

INTERFACE

Bus offline!

BUS/NETWORK connection established.

Data exchange is present.

No operating mode has been selected in the PUMP_CONTROL module.

INTERFACE

Bus fail safe

No valid process data exist.

Communication available.

INTERFACE

Manual

100.0 % freq.

$\Sigma 0 N$

Operating Modes

The following operating modes are possible in interface operation:

- Manual
- Impulse
- Analog
- Batch

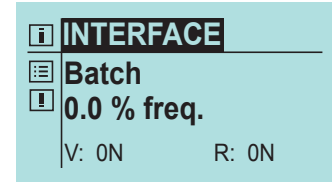
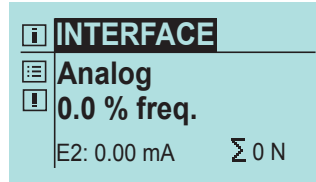
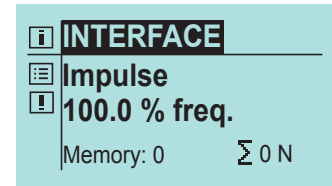
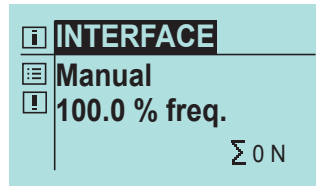

Modules

Thanks to use of the modular design, every sera dosing pump connected to the INTERFACE MODULE can be parametrised according to their own requirements. It is possible to adapt the amount of process data precisely to the needed task.

Explanation of the modules

- | | |
|-------------|--|
| Input data | The modules with the "CONTROL" ending are modules with process data sent to the pump. The pump can be controlled and adjusted using these. |
| Output data | The modules with the "STATE" ending are modules with process data received from the pump. These return the status of the pump. |

The modules can be used individually depending on the application and desired operating mode. However, the „PUMP_CONTROL“ module must always be used for the control of the pump via the network as the operating mode is set here.

The pump can also be monitored for non-interface operating modes using the State modules.

All functions that can also be set using the hand-held control unit can be parametrised via the modules. Only timer operation cannot be adjusted.

The Module Status LED lights continuously after the initialisation of the module by the pump.

The Operation Mode LED indicates the network status. It lights green continuously when process data are being exchanged with a controller. It flashes green if the module is connected to a controller but no process data are being exchanged.

PROFIBUS acyclic data exchange

All modules can be addressed in Slot 1. The index number corresponds to the respective module number from the module table. If data are read acyclically, the size of the data to be read must be specified using the length parameter of the DP-V1 request. If more data are requested than the module provides, the INTERFACE MODULE only returns the data that are available in the respective module. If fewer data than are available are requested, the module only returns data of the requested data quantity.

The module does not check the specified data length for acyclic requests.

If a greater data quantity than available is specified in PROFIBUS or PROFINET, the data cannot be accessed and the device retains the last valid data.

Modules / Input

PUMP_CONTROL

This module is always necessary for the control of the pump irrespective of operating mode. The External Stop Bit that is valid in all operating modes can be set with this module.

Other functions are the setting of the operating mode, reset of the totaliser, acknowledgement of alarms, stroke control for motor pumps. If a valid interface operating mode is selected and the pump is not in interface operation, it automatically switches to interface operation.

MANUAL_CONTROL

Adjustment of the stroke frequency / litre capacity in manual mode.

The operating mode in PUMP_CONTROL must be set to Manual Interface.

PULSE_CONTROL

A pulse for executing a stroke can be sent to the pump using the pulse bit. The pulse is detected during a flank change from 0 to 1. Furthermore, the functionalities of pulse parameters are shown. The stroke frequency / litre capacity can be set using other input data.

ANALOG_CONTROL

Used for operation of the pump using analogue signal. The functionality of analogue parameters is shown via the input data. A module for parametrisation of the analogue input is required for the operation.

BATCH_CONTROL

Start of a batch, reset of the remaining batch and changeover between „normal“ or „analogue“ batch possible.

Otherwise the batch quantity in strokes / litres and the stroke frequency / litre capacity can be set.

INPUT1_CONTROL, INPUT2_CONTROL, INPUT3_CONTROL

Setting of the inputs analogously to the menu.

OUTPUT1_CONTROL, OUTPUT2_CONTROL

Settings of the outputs analogously to the menu.

A_OUTPUT_CONTROL

Settings of the analogue output analogously to the menu.

SLOWMODE_CONTROL

Settings analogously to the Extras menu.

SPEED LIMIT_CONTROL

Settings analogously to the Extras menu.

DOSING_CONTROL

Settings analogously to the Extras menu.

MBE_CONTROL

Settings analogously to the Extras menu.

LEVEL_CONTROL

Settings analogously to the Extras menu.

DEARIATION_CONTROL

Settings analogously to the Extras menu.

FLASH_CONTROL

Settings for the SD card.

TIME_CONTROL

Setting of the system time of the pump.

OPERATION

DIACHANGE_CONTROL

Module for performing a diaphragm change. Analogous to the DIACHANGE_STATE status request.

CALIBRATION_CONTROL

The litre capacity of the pump can be calibrated with this module.

Modules / Output

PUMP_STATE

Statuses of the pump. All operating modes of the pump are displayed here. Even if the pump is not in the Interface mode.

FLOW_STATE

Current delivery rate of the pump in litres / hour or strokes. Valid across operating modes.

COUNTER_STATE

Totaliser of the pump.

IMPULS_STATE

Pump information of the respective set operating mode. No module exists for the Manual operating mode as there is no information except the current delivery rate.

ANALOG_STATE

Pump information of the respective set operating mode. No module exists for the Manual operating mode as there is no information except the current delivery rate.

BATCH_STATE

Pump information of the respective set operating mode. No module exists for the Manual operating mode as there is no information except the current delivery rate.

INPUT1_STATE, INPUT2_STATE, INPUT3_STATE

Information of the inputs / outputs analogous to the associated CONTROL modules.

OUTPUT1_STATE, OUTPUT2_STATE

Information of the inputs / outputs analogous to the associated CONTROL modules.

A_OUTPUT_STATE

Current analogue output current.

CALIBRATION_STATE

Information during a calibration.

PUMP_INFO_STATE

General pump information, Dependent on the pump type.

ALARM_STATE

Display of the error signals of the pump. Active bit means error is present.

Settings (parameters)

No adjustment of the parameters possible.
IP address and subnet can only be allocated via the network.
The following information can be viewed under „Parameters“:

- IP address
- Subnet
- MAC address

PARAMETER	
Address	001...125

The control and parametrisation of the pump are performed using modules that are described in the following table:

No.	Module Name	Data type	Function	Comment
1	PUMP_CONTROL	Byte 1	Bit definition: 0. 0.External Stop ON/OFF 1-3 Operating mode 000 Fail Safe 001 Manual interface 010 Impulse interface 011 Analog interface 100 Batch interface 4. Reset Counter 5. Reserved 6. Acknowledge alarm message 7. Speed control	Must always be implemented to select the operating mode. If a valid interface operating mode is selected and the pump is not in interface operation, it automatically switches to interface operation. Then no other operating mode can be selected. The current stroke counter (not calibrated) and litre counter are reset using Reset Counter. The counter is maintained at 0 if the bit is set. Acknowledge alarm message using flank change to 1. Speed control only has an influence for motor pumps 0 Auto 1 Stroke frequency
2	MANUAL_CONTROL	1. Float	not calibrated: 0.0 - 100.0% calibrated 0.000 l - max. litres/hour	The decimal position of the percentage value is truncated for motor pumps. Specification in litres with up to three decimal places for calibrated pump.
3	IMPULSE_CONTROL	Byte 1 Float 2 Float 3 Word 4	Bit definition: 0. 0.Pulse 1. 1.Pulse memory ON/OFF 2-3 Pulse mode 00 Reduction 01 1/1 10 Transmission 11 Proportional Stroke frequency not calibrated: 0.0 - 100.0% calibrated: 0.000 l - max. litres/hour Pulse Upper Flow not calibrated: 0.0 - 100.0% calibrated: 0.000 l - max. litres/hour Pulse factor / pulse limit 0.999	The value means pulse limit if proportional pulse mode is selected.

OPERATION

No.	Module Name	Data type	Function	Comment
4	ANALOG_CONTROL	Byte 1	Bit definition:	INPUT2_CONTROL or INPUT3_CONTROL must be set as analogue input for the analogue operation.
			0-2 Analogue signal	
			00 0-20 mA	
			01 4-20 mA	
		10 Adjustment		
Byte 2	Analogue I1	Bytes 2-5 are only used standardised for analogue signal.		
Byte 3	Frequency f1	0= 0.0 mA 200= 20.0 mA 155= 15.5 mA		
Byte 4	Analogue I2	0-200		
Byte 5	Frequency f2	0-100%		
5	BATCH_CONTROL	Byte 1	Bit definition:	The remaining batch quantity is zeroed while Bit 1 is set. Can also be used for cancellation of a batch. Batch is also reset by setting External Stop.
			0. Start Batch	
			1. Reset of the remaining batch	
		2. Normal batch / Analogue batch	Two analogue inputs must be parametrised accordingly for Analogue Batch. The batch can be started either by Bit 0 in Batch Control or by the digital input.	
Float 2	Batch Volume	Batch Flow = 0.0 can be set to pause a batch. The speed can be varied during a batch.		
Float 3	Stroke frequency			
		not calibrated: 0.0 - 100.0%		
		calibrated: 0.000 l - max. litres/hour		
6.1	INPUT1_CONTROL	Byte 1	Bit definition:	The function of the INPUTS / OUTPUTS can be set in bus operation by using the respective module. Otherwise, the functionality on delivery is applicable.
		0-3 Input function		
		0000 OFF		
		0001 External stop		
		0010 Venting		
		0011 Impulse		
		0100 Analogue 1/2 changeover		
		0101 Recipe		
		0110 Start Batch		
		4. NC contact / NO contact		

No.	Module Name	Data type	Function	Comment
6.2	INPUT2_CONTROL	Byte 1	Bit definition: 0-3 Input function 0000 OFF 0001 External stop 0010 Venting 0011 Impulse 0100 Analog 1 0101 Recipe 0110 Start Batch 0111 Batch quantity 1000 Batch output 4. NC contact / NO contact	The function of the INPUTS / OUTPUTS can be set in bus operation by using the respective module. Otherwise, the functionality on delivery is applicable.
6.3	INPUT3_CONTROL	Byte 1	Bit definition: 0-3 Input function 0000 OFF 0001 External stop 0010 Venting 0011 Impulse 0100 Analog 2 0101 Recipe 0110 Start Batch 0111 Batch quantity 1000 Batch output 4. NC contact / NO contact	The function of the INPUTS / OUTPUTS can be set in bus operation by using the respective module. Otherwise, the functionality on delivery is applicable.
7.1	OUTPUT1_CONTROL	Byte 1	Bit definition: 0-3 Output function 0000 OFF 0001 Operational 0010 Pump active 0011 Stroke signal 0100 Pre-alarm level 0101 Dry run 0110 Diaphragm rupture 0111 No flow 1000 Group signal 1001 Group fault 1010 Internal error 1011 Batch finished 4. NC contact / NO contact	The function of the INPUTS / OUTPUTS can be set in bus operation by using the respective module. Otherwise, the functionality on delivery is applicable.

No.	Module Name	Data type	Function	Comment
7.2	OUTPUT2_ CONTROL	Byte 1	Bit definition: 0-3 Output function 0000 OFF 0001 Operational 0010 Pump active 0011 Stroke signal 0100 Pre-alarm level 0101 Dry run 0110 Diaphragm rupture 0111 No flow 1000 Group signal 1001 Group fault 1010 Internal error 1011 Batch finished 4. NC contact / NO contact	The function of the INPUTS / OUTPUTS can be set in bus operation by using the respective module. Otherwise, the functionality on delivery is applicable.
8	A_OUTPUT_ CONTROL	Byte 1 Byte 2 Byte 3 Byte 4 Byte 5	Bit definition: 0-1 Analogue output function 00 Analogue input 01 Remaining batch 10 Stroke frequency / litre capacity 2. Reserved 3-4 Analogue output signal 00 0-20 mA 01 4-20 mA 10 Standardisation Analogue I1 0-200 Frequency I1 0-100% Analogue I2 0-200 Frequency I2 0-100%	Bytes 2-5 are only used standardised for analogue signal. 0= 0.0 mA 200= 20.0 mA 155= 15.5 mA
9	SLOWMODE_ CONTROL	Byte 1	Bit definition: 0-1 Suction stroke 00 100% 01 75% 10 50% 11 25%	

No.	Module Name	Data type	Function	Comment
10	SPEEDLIMIT_CONTROL	Byte 1	Speed limit 30-100%	
11	DOSING_CONTROL	Byte 1	Bit definition: 0-3 Sensor type 000 OFF 001 TYPE 8x9x.1 010 TYPE 801x.1 4. Warning / STOP	
		Byte 2	Fault strokes 1-100 strokes	
		Byte 3	Alarm limit 1-100%	Alarm limit only active for sensor TYPE 801x.1.
12	MBE_CONTROL	Byte 1	Bit definition: 0-1 MBE signal 00 OFF 01 NC contact 10 NO contact	
		Byte 2	Sensitivity 0-100%	
13	LEVEL_CONTROL	Byte 1	Bit definition: 0-1 Pre-alarm 00 OFF 01 NC contact 10 NO contact 2-3 Dry run 00 OFF 01 NC contact 10 NO contact	
14	DEAERATION_CONTROL	Byte 1	Bit definition: 0. Start venting 1-2 Control 00 OFF 01 External 10 Interval 11 Automatic	Start of the venting only for external control
		Byte 2	Interval time 15-100 minutes	
		Word 3	Venting time 10-300 seconds	

No.	Module Name	Data type	Function	Comment
15	FLASH_CONTROL	Byte 1	Bit definition: 0. Signals ON/OFF 1. Operating data ON/OFF 2-3 Write period 00 1 minute 01 5 minutes 10 10 minutes 11 30 minutes	
16	TIME_CONTROL	Byte 1 Byte 2 Byte 3 Byte 4 Byte 5 Byte 6	Bit definition: 0. Set time Day 1-31 Month 1-12 Year 0-105 Hour 0-24 Minute 0-59	The time is applied when changing the bit from 0 to 1. Year starting from 2000. 0 corresponds to the year 2000. 16 corresponds to 2016. Input starting from year 2000 possible. MBE Change must be performed after setting the time to reset the timer. The old time setting is retained if an invalid date is transmitted.
17	DIACHANGE_CONTROL	Byte 1	Bit definition: 0. Start of the diaphragm change 1. Change completed	The change is started with the change of Bit 0 from 0 to 1. The change is completed with the change of Bit 1 from 0 to 1.
18	CALIBRATION_CONTROL	Byte 1 Word 2 Byte 3 Float 4	Bit definition: 0. Start Calibration 1. Cancel Calibration 2. Save Calibration Value 3. Calibration ON/OFF Calibration strokes 1-9999 strokes Calibration speed 1-100% Calibration result 0.000 - max. value in l	The calibration starts with the change of Bit 0 from 0 to 1. A valid value for the calibration strokes and calibration speed must be present. The calibration value is saved with the change of Bit 2 from 0 to 1. A value greater than 0 must exist in Float 4 and the calibration must be completed for this. Using Bit 3, the calibration can be deactivated for a calibrated pump by setting the bit to 1. The control is then performed with specification of a stroke frequency.

Daten von Modul zum Master

Nr.	Modul Name	Datentyp	Funktion	Bemerkung
19	COUNTER_STATE	1.Float	Aktuelle Fördermenge Nicht Kalibriert: Hübe seit dem Einschalten oder Reset Kalibriert: Liter seit dem Einschalten oder Reset	
		2.Long (4Byte)	Gesamtfördermenge In Liter, seit Auslieferung der Pumpe	
		3.Long (4Byte)	Gesamthubzahl In Hübe, seit Auslieferung der Pumpe	
		4.Long (4Byte)	Betriebsstunden In Stunden, seit Auslieferung der Pumpe	
		5.Long (4Byte)	Membranstunden In Stunden, seit Auslieferung oder letzten Membranwechsel	
20	PUMP_STATE	1.Byte	Bitdefinition: 0.-3. Operation Mode 0000 Interfacebetrieb Fail Safe 0001 Manuel Interface 0010 Impuls Interface 0011 Analog Interface 0100 Charge Interface 0101 Manuel 0110 Impuls 0111 Analog 1000 Charge 1001 Reserve 1010 Timer	
		2.Byte	Pump State 2 0. Pumpe AUS/AN 1. Hubsignal 2. Sammelmeldung vorhanden 3. Sammelstörung vorhanden 4. Fehlermeldung quittiert ausgeführt 5. Membranwechsel aktiv 7. Pumpe kalibriert Nein / Ja	Nach jeden ausgeführten Hub springt das 1.Bit für 160 ms von 0 auf 1.

No.	Module Name	Data type	Function	Comment
21	FLOW_STATE	1.Float	Aktuelle Förderleistung nicht Kalibriert: 0,0 - 100,0% kalibriert: 0,000l - max Liter / Stunde	
22	IMPULS_STATE	1.Byte	Bitdefinition: 0. Impuls 1. Impulsspeicher EIN/AUS 2.-3. Impulsmodus 00 Teiler 01 1/1 10 Multiplikation 11 Proportional	
		1.Word	Impuls Memory 0-999	Vorgemerkte Impulse
23	ANALOG_STATE	1.Byte	Bitdefinition: 0.-2. Analogsignal 00 0-20 mA 01 4-20 mA 10 Normiert	
		2.Byte	Analog I1 0-200	
		3.Byte	Analog Frequenz f1 0-100%	
		4.Byte	Analog I2 0-200	
		5.Byte	Analog Frequenz f2 0-100%	0=0mA 150=15,0mA 200=20,0mA
		6.Byte	Analog Current 0-250	Es wird der Strom am aktiven Eingang angezeigt.
24	BATCH_STATE	1.Byte	Bitdefinition: 0. Charge wird gerade gefördert	
		2.Float	Chargen Volumen Vorgabe gemäß BATCH_CONTROL oder durch Analogeingang	
		3.Float	Chargengeschwindigkeit Vorgabe gemäß BATCH_CONTROL	
		4.Float	Restchargenmenge 0.001l - Max Chargen Volumen	

No.	Module Name	Data type	Function	Comment
25.1	INPUT1_STATE	1.Byte	Bitdefinition: 0.-3. Inputfunktion 0000 AUS 0001 Extern Stopp 0010 Entlüften 0011 Impuls 0100 Analog Umschaltung 0101 Rezept 0110 Start Charge 4. Öffner / Schließer 5. gesetzt / nicht gesetzt	
25.2	INPUT2_STATE	1.Byte	Bitdefinition: 0.-3. Inputfunktion 0000 AUS 0001 Extern Stopp 0010 Entlüften 0011 Impuls 0100 Analog 1 0101 Rezept 0110 Start Charge 0111 Chargen Menge 1000 Chargen Leistung 4. Öffner / Schließer 5. gesetzt / nicht gesetzt	5. Bit nicht gültig bei Analog Funktion.
25.3	INPUT3_STATE	1.Byte	Bitdefinition: 0.-3. Inputfunktion 0000 AUS 0001 Extern Stopp 0010 Entlüften 0011 Impuls 0100 Analog 1 0101 Rezept 0110 Start Charge 0111 Chargen Menge 1000 Chargen Leistung 4. Öffner / Schließer 5. gesetzt / nicht gesetzt	

OPERATION

No.	Module Name	Data type	Function	Comment
26.1	OUTPUT1_STATE	1.Byte	Bitdefinition: 0.-3 Outputfunktion 0000 AUS 0001 betriebsbereit 0010 Pumpe Aktiv 0011 Hubsignal 0100 Niveau Voralarm 0101 Trockenlauf 0110 Membranbruch 0111 Keine Strömung 1000 Sammelmeldung 1001 Sammelstörung 1010 Interner Fehler 1011 Charge beendet 4. Öffner / Schließer 5. gesetzt / nicht gesetzt	
26.2	OUTPUT2_STATE	1.Byte	Bitdefinition: 0.-3 Outputfunktion 0000 AUS 0001 betriebsbereit 0010 Pumpe Aktiv 0011 Hubsignal 0100 Niveau Voralarm 0101 Trockenlauf 0110 Membranbruch 0111 Keine Strömung 1000 Sammelmeldung 1001 Sammelstörung 1010 Interner Fehler 1011 Charge beendet 4. Öffner / Schließer 5. gesetzt / nicht gesetzt	
27	A_OUTPUT_STATE	1.Byte	Analog Out Current 0-200	0=0mA 150=15,0mA 200=20,0mA

No.	Module Name	Data type	Function	Comment
28	CALIBRATION_STATE	1.Byte	Bitdefinition: 0. Start Kalibration 1. Abbruch Kalibration 2. Kalibrierwert Speichern 3. Kalibrierung EIN/AUS 4. Kalibrierung Aktiv 5. Kalibrierung Fertig	
		1.Word	Calibration Remain Strokes 0-999	
29	PUMP_INFO_STATE	1.Float	MAX_FLOW Maximale Förderleistung in l/h	
		1.Word	MAX_STROKE Maximale Hubfrequenz in Hübe/Min	
		1.Word	SERA-CODE 0-65535	
		1.Long	SERIENNUMMER 0-9999999	
		1.Byte	SW vM01.xxx	
		1.Byte	HW vHC01.xxx	Die letzten 3 Ziffern der HW und SW-Versionen werden übertragen.

No.	Module Name	Data type	Function	Comment
30	ALARM_STATE	1. Long (4 Byte)	1. Byte	
			0. Bit Antriebssörung	
			1.Bit Kalibrierbereich verlassen	1.Bit (nur Pumpen mit HLE)
			2.Bit Sollwert nicht erreichbar	
			3.Bit Störung Hubsensor	
			4.Bit keine Huberkennung	
			5.Bit Reserve	
			6.Bit Antrieb zu langsam	
			7.Bit Reserve	
			8.Bit Membranbruch	
			9.Bit Niveau Voralarm	
			10.Bit Niveau Trokenlauf	
			11.Bit Netzspannung zu hoch	
			12.Bit Netzspannung zu gering	
			13.Bit keine Strömung, nur bei aktiver Durchflussüberwachung	
			14.Bit Durchfluss zu gering	
			15.Bit Überlauf Impulsspeicher	
			16.Bit Übertemperatur, nur Schrittmotorpumpe	
			17.Bit Servicezeit überschritten	
			18.Bit Störung SD-Karte	
			19.Bit Analogsignal größer 20mA	
			20.Bit Analogsignal kleiner 4mA	
			21.Bit Analogsignal größer 25mA	
			22.Bit Reserve	
			23.Bit Reserve	
			24.Bit Reserve	
			25.Bit Reserve	
			26.Bit Reserve	
			27.Bit Reserve	
			28.Bit Reserve	
			29.Bit Reserve	
			30.Bit Reserve	
			31.Bit Reserve	

Diagnostics signals

The **sera** INTERFACE MODULE has two diagnostics messages that are output in the network-specific protocol (PROFIBUS / PROFINET). A present message is indicated by flashing once for a short time of the Module Status LED. The messages can be read in plain text using the diagnostics function of the Engineering tool.

The following messages can be generated:

- PUMP_WARNING
There is a signal in the pump. The pump is still operational.
- PUMP_ERROR
There is a fault in the pump. The pump is not operational.
- ALARME_STATE
The module can be used to evaluate the error.

Error message

Error message	Possible cause	Corrective action
Fault bus module	Module has been removed from the pump during operation.	Disconnect voltage. Connect module to pump. Switch on voltage again.
Fault bus module	Internal error of the communication module.	Please contact the manufacturer.

Maintenance and cleaning

The INTERFACE MODULE is maintenance-free. Clean with a moist cloth. Rub dry afterwards.



ATTENTION

Do not use any solvents! These can attack the surfaces.

Decommissioning

- Disconnect device from the power supply.
- Detach electrical connections.
- Take device out of operation.



ATTENTION

Only let the decommissioning be performed by authorised and qualified personnel.

Disposal

Dispose of correctly and comply with the currently applicable local regulations after shutdown and dismantling.



ATTENTION

Dispose of electronics separately!

FOLLOW US



sera GmbH
sera-Str. 1
34376 Immenhausen
Germany
Tel. +49 5673 999 00
Fax +49 5673 999 01
info@sera-web.com
www.sera-web.com

TA05-02 EN 10/2020. **sera**® is a registered trademark by **sera GmbH**.
Subject to change without notice. **sera** accepts no liability for errors or misprints.